

**A****CCE RR  
REVISED**Question Paper Serial No. **30**

ಒಟ್ಟು ಮುದ್ರಿತ ಪುಟಗಳ ಸಂಖ್ಯೆ : 12 ]

Total No. of Printed Pages : 12 ]

ಒಟ್ಟು ಪ್ರಶ್ನೆಗಳ ಸಂಖ್ಯೆ : 38 ]

Total No. of Questions : 38 ]

ಸಂಕೇತ ಸಂಖ್ಯೆ : **83-E**Code No. : **83-E**

ವಿಷಯ : ವಿಜ್ಞಾನ

**Subject : SCIENCE**

(ಭೌತಶಾಸ್ತ್ರ, ರಸಾಯನಶಾಸ್ತ್ರ ಮತ್ತು ಜೀವಶಾಸ್ತ್ರ / Physics, Chemistry &amp; Biology )

( ಇಂಗ್ಲಿಷ್ ಭಾಷಾಂತರ / English Version )

( ಹೊಸ ಪಠ್ಯಕ್ರಮ / New Syllabus )

( ಪುನರಾವರ್ತಿತ ಶಾಲಾ ಅಭ್ಯರ್ಥಿ / Regular Repeater )

ದಿನಾಂಕ : 28. 09. 2020 ]

[ Date : 28. 09. 2020

ಸಮಯ : ಬೆಳಿಗ್ಗೆ 10-30 ರಿಂದ ಮಧ್ಯಾಹ್ನ-1-45 ರವರೆಗೆ ] [ Time : 10-30 A.M. to 1-45 P.M.

ಗರಿಷ್ಠ ಅಂಕಗಳು : 80 ]

[ Max. Marks : 80

**General Instructions to the Candidate :**

1. This Question Paper consists of 38 objective and subjective types of questions.
2. This question paper has been sealed by reverse jacket. You have to cut on the right side to open the paper at the time of commencement of the examination. Check whether all the pages of the question paper are intact.
3. Follow the instructions given against both the objective and subjective types of questions.
4. Figures in the right hand margin indicate maximum marks for the questions.
5. The maximum time to answer the paper is given at the top of the question paper. It includes 15 minutes for reading the question paper.

30

**RR (A)-1124 ★**

[ Turn over

ಇಲ್ಲಿಂದ ಕತ್ತರಿಸಿ

TEAR HERE TO OPEN THE QUESTION PAPER

ಪ್ರಶ್ನೆಪತ್ರಿಕೆಯನ್ನು ತೆರೆೆಯಲು ಇಲ್ಲಿ ಕತ್ತರಿಸಿ

Tear here

- I. Four alternatives are given for each of the following questions / incomplete statements. Choose the correct alternative and write the complete answer along with its letter of alphabet. 8 × 1 = 8

1. The type of reproduction found in Spirogyra is

- (A) Budding
- (B) Fragmentation
- (C) Vegetative reproduction
- (D) Spore formation.

2. Identify the correct electron dot structure of nitrogen molecule in the following :

- (A)  $\text{:N::N:}$
- (B)  $\text{:}\ddot{\text{N}}\cdot\cdot\ddot{\text{N}}\text{:}$
- (C)  $\cdot\ddot{\text{N}}\text{:}\text{:}\ddot{\text{N}}\cdot$
- (D)  $\cdot\text{N::N}\cdot$

3. The sky as seen from the surface of the moon appears dark because,

- (A) only a little of the blue and violet colours are scattered
- (B) all the colours are absorbed by the atmosphere present in the moon
- (C) all the colours are scattered
- (D) atmospheric particles needed to scatter the light are not present.

4. The atomic numbers of elements *A*, *B*, *C* and *D* are 3, 9, 4 and 8 respectively. Elements having metallic nature among these are
- (A) *B* and *D*
- (B) *A* and *B*
- (C) *A* and *C*
- (D) *B* and *C*.
5. Observe the diagram.

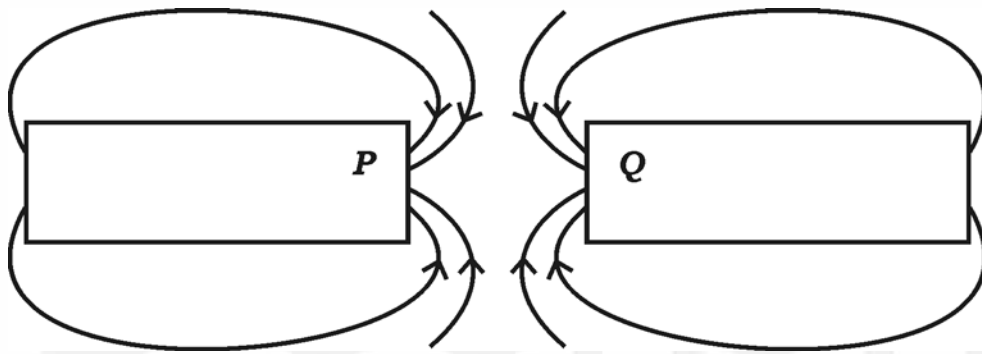

The magnetic poles represented by *P* and *Q* respectively are

- (A) south ( *S* ) and south ( *S* )
- (B) north ( *N* ) and south ( *S* )
- (C) north ( *N* ) and north ( *N* )
- (D) south ( *S* ) and north ( *N* ).
6. The site of complete digestion of carbohydrates, proteins and fats is
- (A) stomach
- (B) large intestine
- (C) small intestine
- (D) liver.

7. The image of the English letter “L” in convex mirror looks like

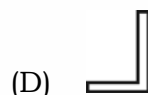
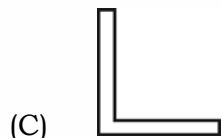
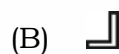
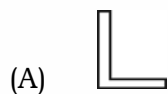

8. The name and the molecular formula of the unsaturated hydrocarbon having general formula  $C_n H_{2n}$  and containing 3 carbon atoms is

(A) propane,  $C_3 H_8$

(B) Cyclopropane,  $C_3 H_6$

(C) Propyne,  $C_3 H_4$

(D) Propene,  $C_3 H_6$

II. Answer the following questions.

$8 \times 1 = 8$

9. In the alpine meadows of the great Himalayan National Park, the practice of regular grazing by sheep was put to an end. What are the effects on the meadows due to this measure ?

10. What are amphoteric oxides ?

11. Observe the given incomplete diagram.

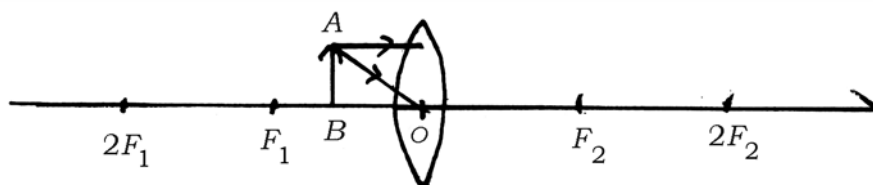

Complete the diagram by drawing refracted rays and show the image formed.

RR (A)-1124 ★

12. Can detergent be used to test hardness of water ? Give reason.
13. Name the poisonous gas produced due to incomplete combustion of fossil fuels.
14. A student sitting in the last bench has difficulty in reading the blackboard writing. Which is the defect of vision the student has ? How can it be corrected ?
15. Manufacturers of chips, flush the packets of chips with nitrogen gas. Why ?
16. Suggest any two measures to avoid overloading in domestic circuits.

III. Answer the following questions.

8 × 2 = 16

17. Explain the two methods to estimate the age of fossils.
18. Draw the diagram of the arrangement of apparatus to show that acid solution in water conducts electricity and label the battery.

OR

Draw the diagram of the arrangement of apparatus showing the reaction of zinc granules with dilute sulphuric acid and testing hydrogen gas by burning and label the zinc granules.

19. Eating chapati by chewing it very slowly tastes sweeter. Why ?

RR (A)-1124 ★

[ Turn over



24. Draw the diagram of the apparatus used in refining of copper from copper sulphate solution. Label the following parts :

- i) Cathode
- ii) Anode mud.

IV. Answer the following questions.

9 × 3 = 27

25. a) State the laws of refraction of light.

- b) In the given figure,  $AB$  is the incident ray,  $BC$  is the refracted ray and  $MN$  is the normal at the point of incidence. Which medium is more denser ? Why ?

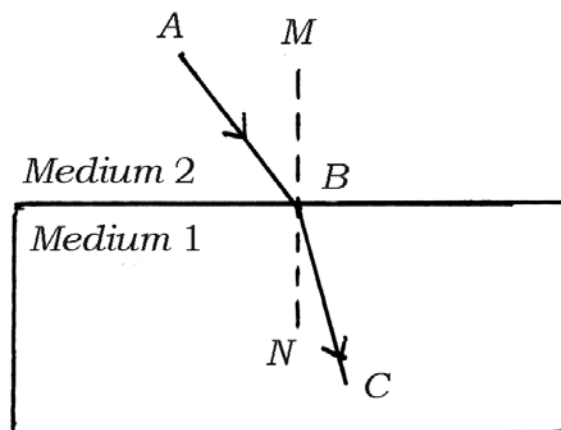

OR

- a) Differentiate between convex mirror and concave mirror.
- b) Define the principal focus of a convex lens.

26. Strips of zinc, iron, magnesium and copper are taken in the test tubes A, B, C and D respectively. Same quantity of ferrous sulphate solution is added to these test tubes. In which test tubes chemical reaction will occur ? Why ? Write the chemical equations for the reactions taking place here.
27. Mendel crossed plants bearing red flowers ( RR ) with the plants bearing white flowers ( rr ) and produced progeny from them. The plants with red flowers obtained in  $F_1$  generation were different from the plants with red flowers of parental generation. Why ? Explain with reasons.
28. a) Explain how is nuclear energy generated in power reactors. How is electricity produced from nuclear energy ?
- b) Mention two hazards of nuclear power reactor.

OR

- a) Explain why we are looking at the alternative sources of energy.
- b) Mention the advantages and disadvantages associated with solar cells.
29. Write the balanced chemical equations for the following chemical reactions. How can we confirm by observation that these chemical reactions are taking place ?
- a) Lead nitrate is heated.
- b) Sodium sulphate reacts with Barium chloride.

RR (A)-1124 ★



30. How are the functions of arteries, veins and capillaries are interrelated in the circulation of blood ?

OR

How does transportation of water take place over the heights in a plant ?  
Explain.

31. Draw the diagram to show the recombination of the spectrum of white light and label the following parts.

- a) The ray of light that bends the most
- b) The ray of light that bends the least.

32. Write the molecular formulae and two uses of each of the following compounds :

- a) Bleaching powder
- b) Plaster of Paris.

OR

What is a strong acid ? Explain how tooth decay is caused. How can it be prevented ?

33. Give reason :

- a) Food chains generally consist of only three or four steps.
- b) Decomposers play an important role in an ecosystem.
- c) Protecting of ozone layer is necessary.

V. Answer the following questions.

4 × 4 = 16

34. a) What are structural isomers ? Write two structures of butane molecule.
- b) How would you distinguish experimentally between an alcohol and a carboxylic acid ?
35. Draw the diagram showing longitudinal section of human brain. Label the following parts :
- a) Mid brain
- b) Gland which stimulates growth in all organs.
36. Observe the given diagram. Explain the experiment related to this diagram. What conclusions can be drawn from this experiment ?

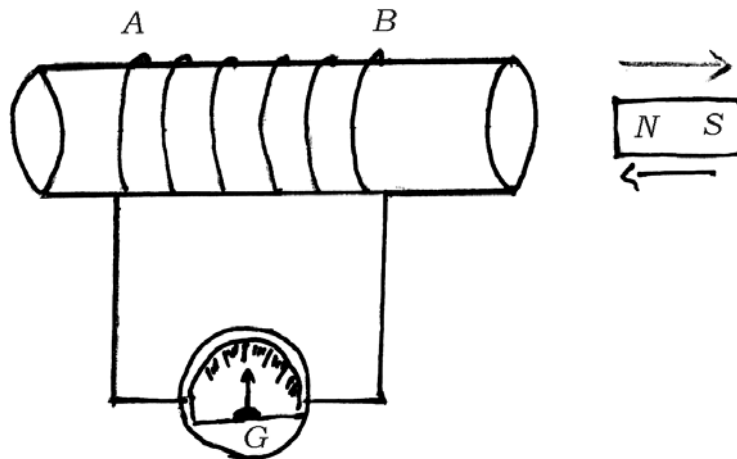

37. a) How does menstruation occur ?
- b) How the process of budding in hydra is different from Bryophyllum ?

OR

- a) Explain the development of fertilized egg into a foetus in women.
- b) In humans, how the surgical contraceptive methods can be used to prevent pregnancy ?

RR (A)-1124 ★

VI. Answer the following question.

1 × 5 = 5

38. What is the meaning of the statement “The potential difference between two points is 1 V” ? Name the device used to measure potential difference. What is resistance of a conductor ? What is electric power ? Write three formulae used to find electric power.

=====

